

Bandido creates products that generate harmony and warmth in each space where they are present. We hope you enjoy your new product and exceeds all your expectations.

You can get more information about the maintenance of your product and warranty by scanning the following QR Code.



B

DBH 02 III

Sconce Lamp

Instructions

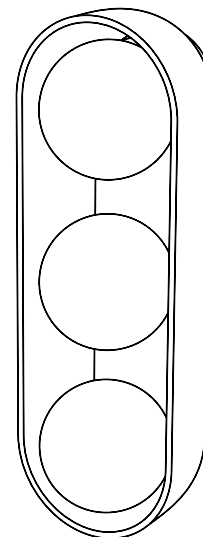

CDMX

Aristóteles 127
Polanco IV Sección Miguel Hidalgo
11550 CDMX, México

+52 555 087 2443

PUEBLA

Callejón del Cristo 2 Int. 6 A
Col. San José del Puente
72150 Puebla, Pue, México

+52 222 688 8442

Light Source

3x 2.5 W G9 LED COB 250 lm

120 - 127 V - 60 Hz 0.020 A

2700 K

Included

Indoor Use

bandidostudio.com

Bandido

BULB REPLACEMENT

1

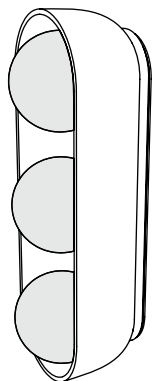

2

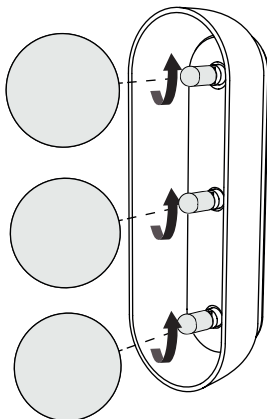

3

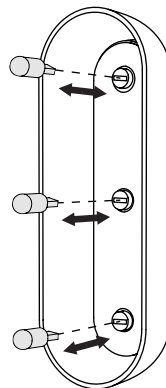

4

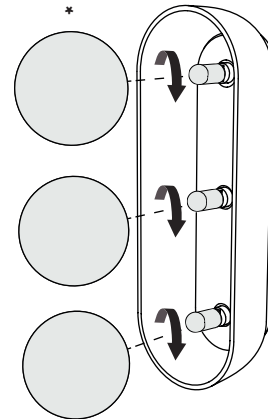

* Align and screw in slightly; the diffuser may break.



Handle with care, fragile materials.



Use only LED bulbs.

INSTALLATION GUIDE

Sconce Lamp



CAUTION: Turn off the power supply before executing any electrical installation.

We suggest that any electrical work be performed by a qualified specialist.

Included Parts:

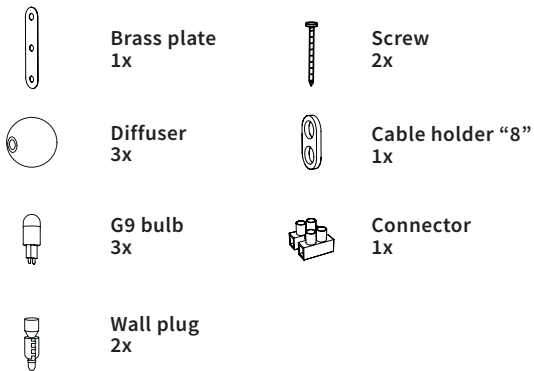

1 Placement of wall plugs. Before drilling, mark the location of the screws according to the **installation template**.

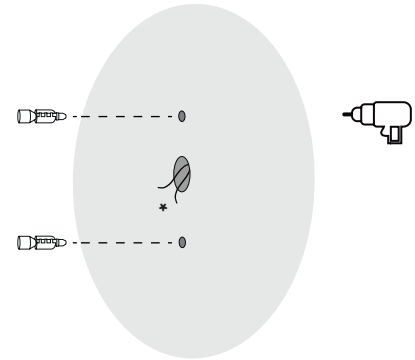

* Electrical supply cables.

2 Connect + to + and - to - using the connector.

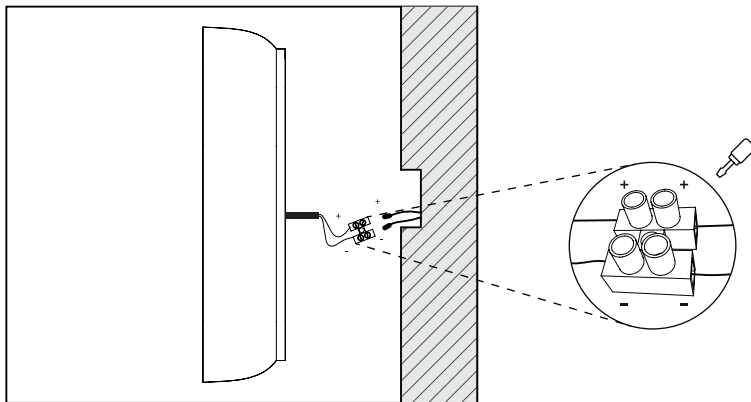

* Insert the cables into the wall cavity.

3 Fix the module to the wall.

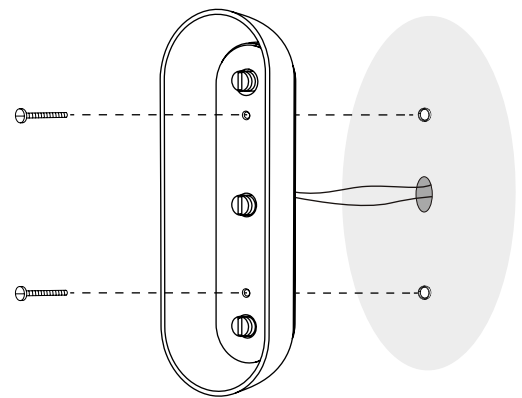

4 Install the brass cover, followed by the LED Bulb and Glass Diffuser.

* Align and screw gently to avoid jamming.

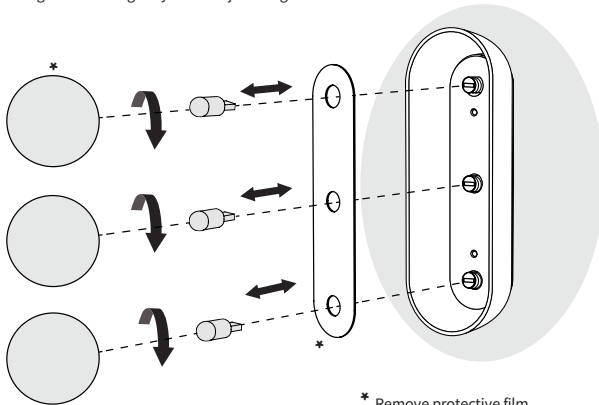

* Remove protective film.



Handle with care, fragile materials.

