

Bandido creates products that generate harmony and warmth in each space where they are present. We hope you enjoy your new product and exceeds all your expectations.

You can get more information about the maintenance of your product and warranty by scanning the following QR Code.



B

DUO

Sconce Lamp

Instructions

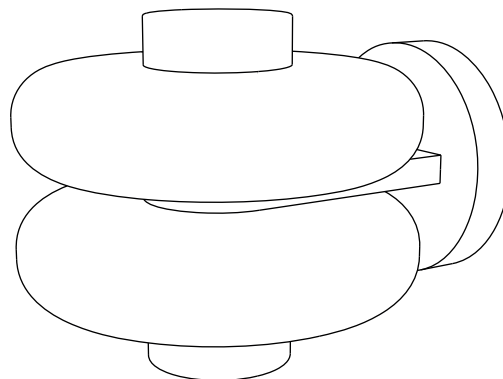

Light Source

1 x lamp LED GU10 Bulb 7 W
100 V ~ 130 60 Hz 7 W LED 0.07 - 0.05 A
Included
7 Wh

Indoor Use

Distrito Bandido

RFC: DBA200515RT3
Callejón del Cristo 2 - 6A
Col. San José del Puente
C.P. 72150. Puebla, Puebla

+52 (222) 688 8442

www.bandidostudio.com

Bandido

Bulb Replacement

Tutorial

1

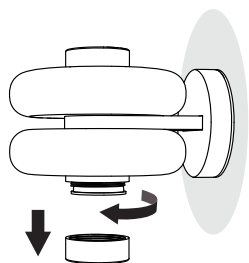

2

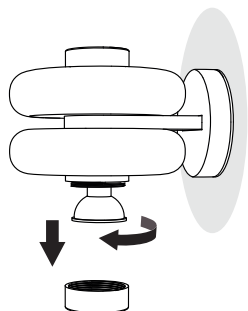

3

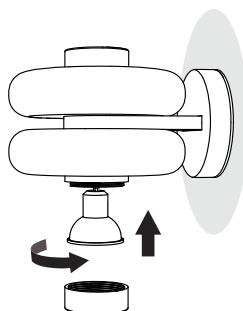

4

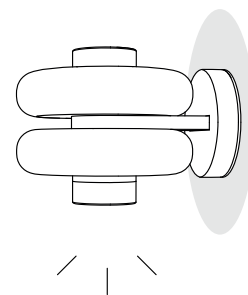

Handle with care, fragile materials.





Use only LED bulb

Installation Guide

Sconce Lamp

We suggest that any electrical work should be performed by a qualified electrician.

 **CAUTION: Turn off the power supply before executing any electrical installation.**

 **We recommend incorporating structural reinforcement elements in drywall or comparable wall and ceiling finishes.**

Parts included.

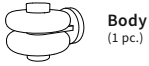

Body
(1 pc.)



Screw
(2 pcs.)



Steel Plate
(1 pc.)





Wall Plug
(2 pcs.)

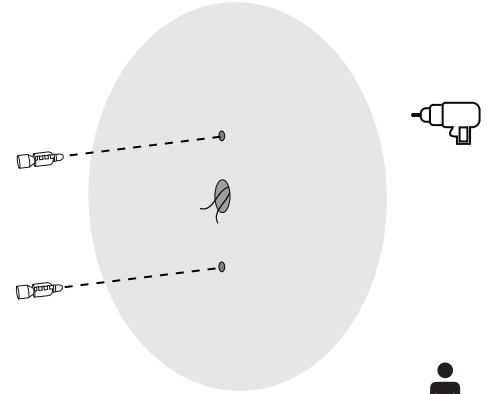

GU10 Bulb
(1 pc.)

1 Placement of wall plugs. Before drilling, mark the location of the screws according to the steel plate and ensure they are level and vertical.



The installation should be done by two people.  x2

2 Steel plate fastening.

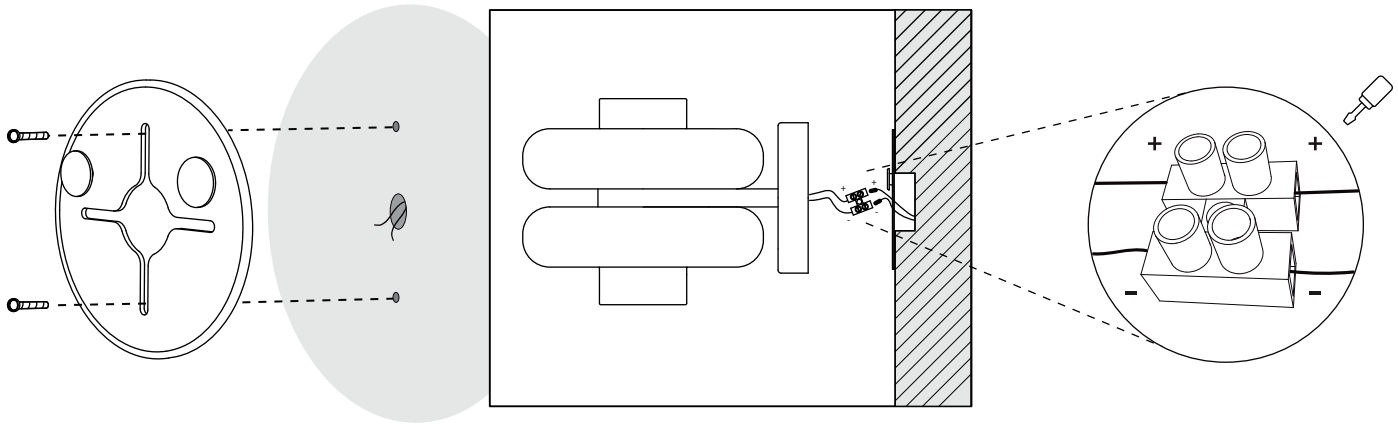

4 Locate the body on the steel plate.

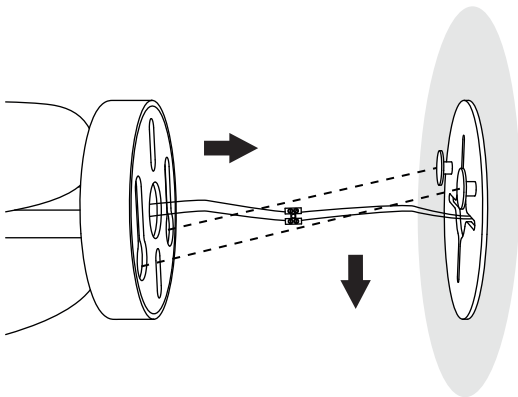

*Place cables through the steel plate.

 **Handle with care, fragile materials.**